

PLAN OF CAR IN SHAFT

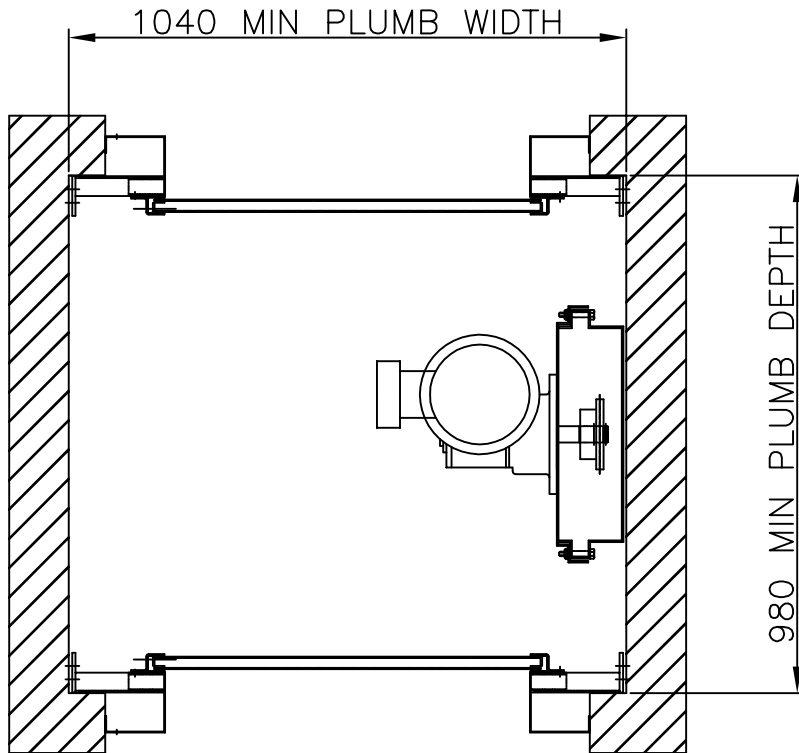

PLAN OF PIT



TITLE
 SHAFT PLAN
 MODEL - MANWELL 100kg
 FRONT & REAR OPENINGS
 PREMISES N/A

DRAWN	SH
DATE	12/02/2009
SCALE	N.T.S.
REVISION	
DWG No	